



# TYGER®

## FENDER FLARE

TG-FF8C4057

PLEASE READ AND FOLLOW THIS APPROVED INSTRUCTION CAREFULLY BEFORE INSTALLATION. FAILURE TO DO SO MAY CAUSE DAMAGE TO THE VEHICLE AND WILL INVALIDATE THE WARRANTY.

### PRIOR TO INSTALLATION

- Remove contents from box. Verify all parts are present and free from any defects or damage.
- Make sure installation is done on a non-abrasive surface to avoid scratching the flare surface.
- Pre-fit each flare to the vehicle body to ensure they suit the profile of the vehicle.
- Remove existing decals and mud flaps on the vehicle that may interfere with flare installation.
- Make sure all flares and fender wheel well are clean as the presence of dirt or sand may scratch auto body paint.
- Suggest removing the tire before installation for easier access.
- Do not use any harsh abrasive detergent to clean the flare.

### PAINTING

Painted flares cannot be returned. Test fit before painting. We are not responsible for any costs that may incur if flares were painted without test fitting.

- Clean surface to be painted with a good grade degreaser. Do not use lacquer thinner or any solvent based product.
- Wipe flare surface completely dry with a tack rag prior to paint.
- Application of plastic adhesion promoter for PP plastic as per your paint system manufacturer's recommendations is required.
- Use a high quality enamel or polyurethane automotive paint to paint the flares.
- Not recommend to paint the edge trim, but if desired use a flex additive.

### WARNING

Dirt or debris may become lodged between flares and vehicle's fenders causing scratching and paint wear from vehicle vibration. TYGER is not responsible for any damage, and installation is done with buyer's understanding that this damage may potentially occur.

### SAFETY INFORMATION

- Before driving, ensure that flare is properly secured to vehicle.
- Do not use automatic "brush-style" car wash.
- Periodically check all components for tightness.

### Tools Required



Electric Drill



5/16" Drill



#2 Phillips Bit



Utility Knife



1/2" Wrench



Jack Stands

### Hardware Included



[A]



[B]

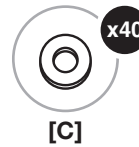

[C]



[D]

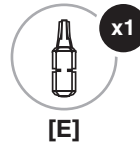

[E]



[F]

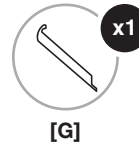

[G]

**DAMAGED or MISSING PARTS?**

[www.TygerAuto.com/Contact](http://www.TygerAuto.com/Contact)



## EDGE TRIM INSTALLATION

- Peel 2 inches of red backing away from one end of Edge Trim **[A]** .
- Apply Edge Trim over top edge of flare with adhesive side contacting inside edge of flare.
- Press Edge Trim into place and apply thumb pressure to ensure good adhesion, pull away red backing as you work your way around flare edge in one-foot increments. (Fig 1)

**NOTE:** Do not stretch Edge Trim during application.

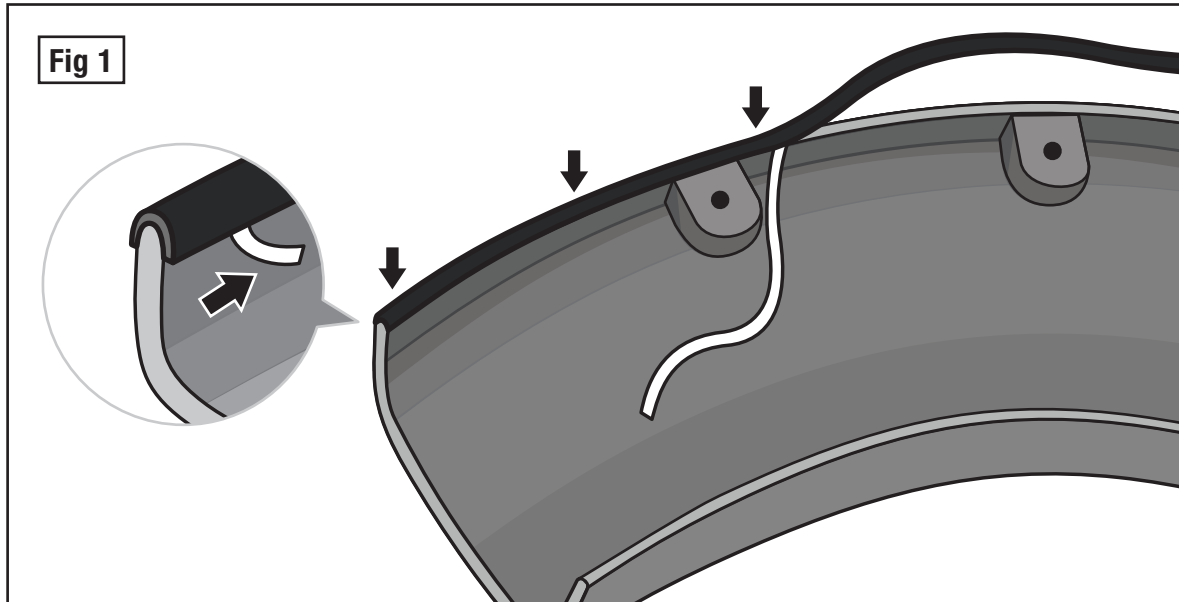

## DECORATIVE RIVET INSTALLATION

- Install Torx Bolt **[B]** with Washer **[C]** through each of the top holes around the flare and secure by using Nylock Nut **[D]** on the other side (Fig 2). Tighten by using socket wrenches and the supplied Torx Bit **[E]**. Do not over-tighten as this may damage the flare.

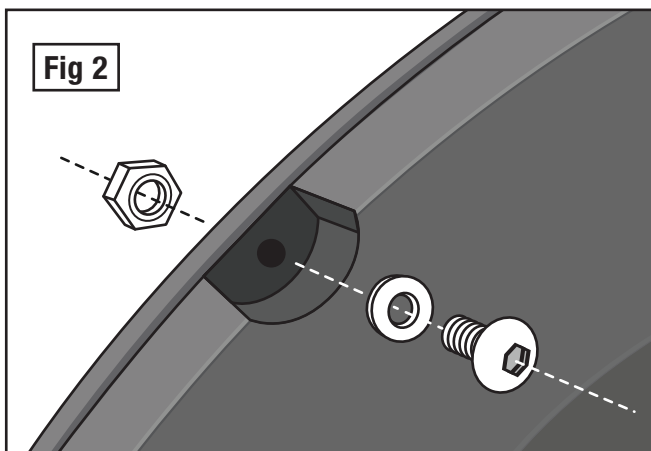

**IMPORTANT:** Do not drill holes to the vehicle body as rivets are decorative and fasten only to the flare. Do not attempt to use the bolts to fasten flare to vehicle body.

## EXTRA NOTES

- Prior to installation, please use rust-resistant paint or rust primer on exposed metals to prevent rusting. Spray inner fender wells with undercoating after flare installation.
- Some modifications may be needed to maintain a minimum of 4" clearance between flares and exhaust pipes to avoid exhaust gases discharge directly onto fender flares.
- For vehicle with large tires, care must be taken to ensure tires do not make contact with flares.

## Driver Side Flare Installation

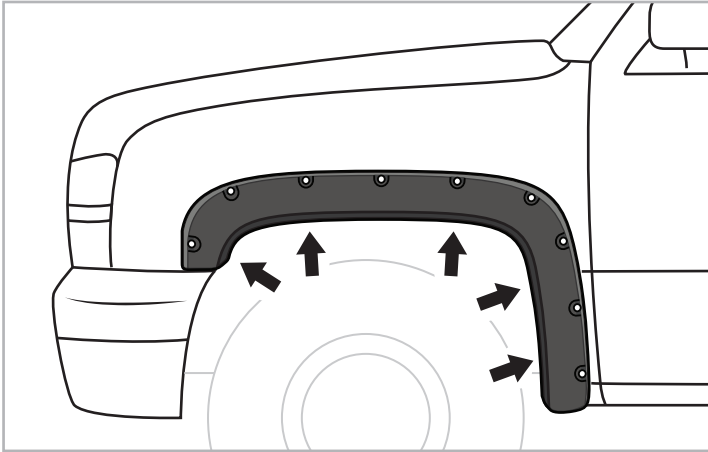

**STEP 1:** Position front flare in place by aligning up holes in flare with vehicle's existing factory holes. Starting at the top center, install 6 supplied Tufloks [F].

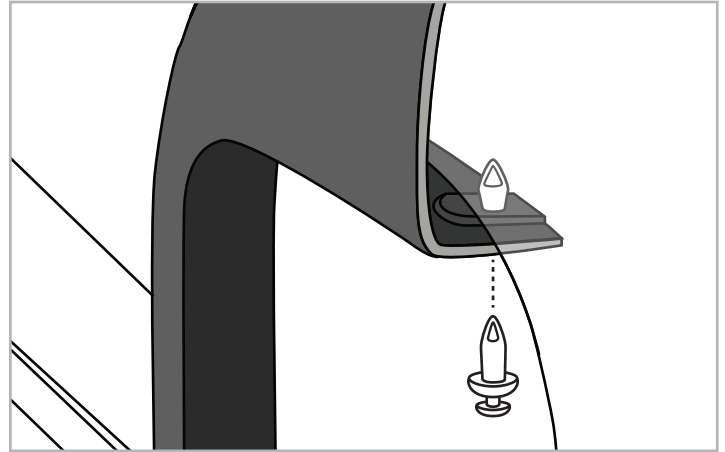

**STEP 2:** Insert the supplied Tuflok [F] through holes in flare and into vehicle's factory holes.

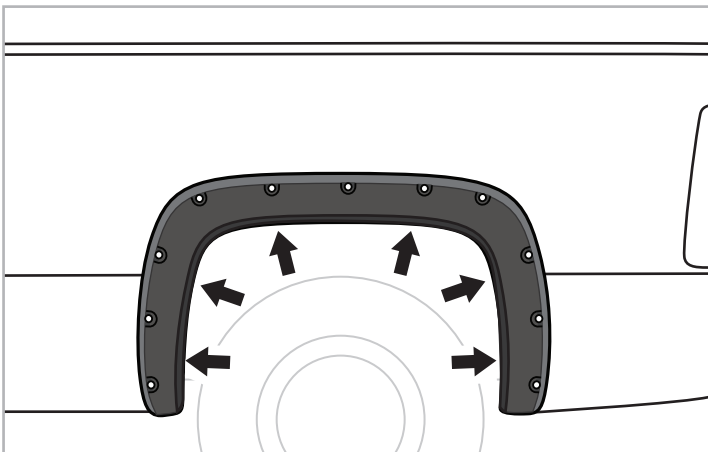

**STEP 3:** Position rear flare in place by aligning up holes in flare with vehicle's existing factory holes. Starting at the top center, install 6 supplied Tufloks [F].

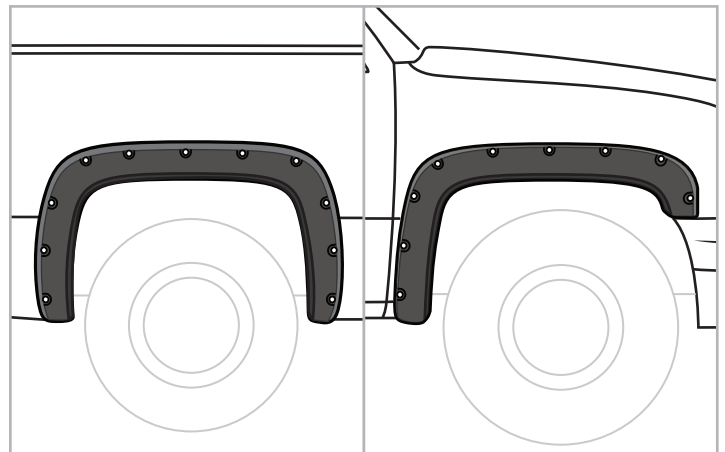

**STEP 4:** Repeat Step 1-3 for passenger side installation.

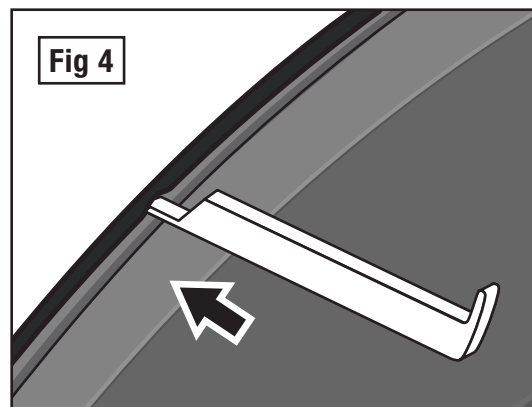
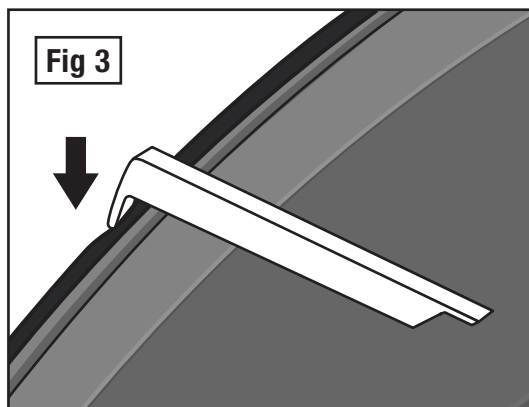

**STEP 26:** If needed use supplied tool [G] to trim outer edge (Fig 3) and inner edge (Fig 4) by inserting tool ends then sliding around the entire edge trims from one end to the other as shown in above pictures.

# FITMENT OR GAP ISSUE?

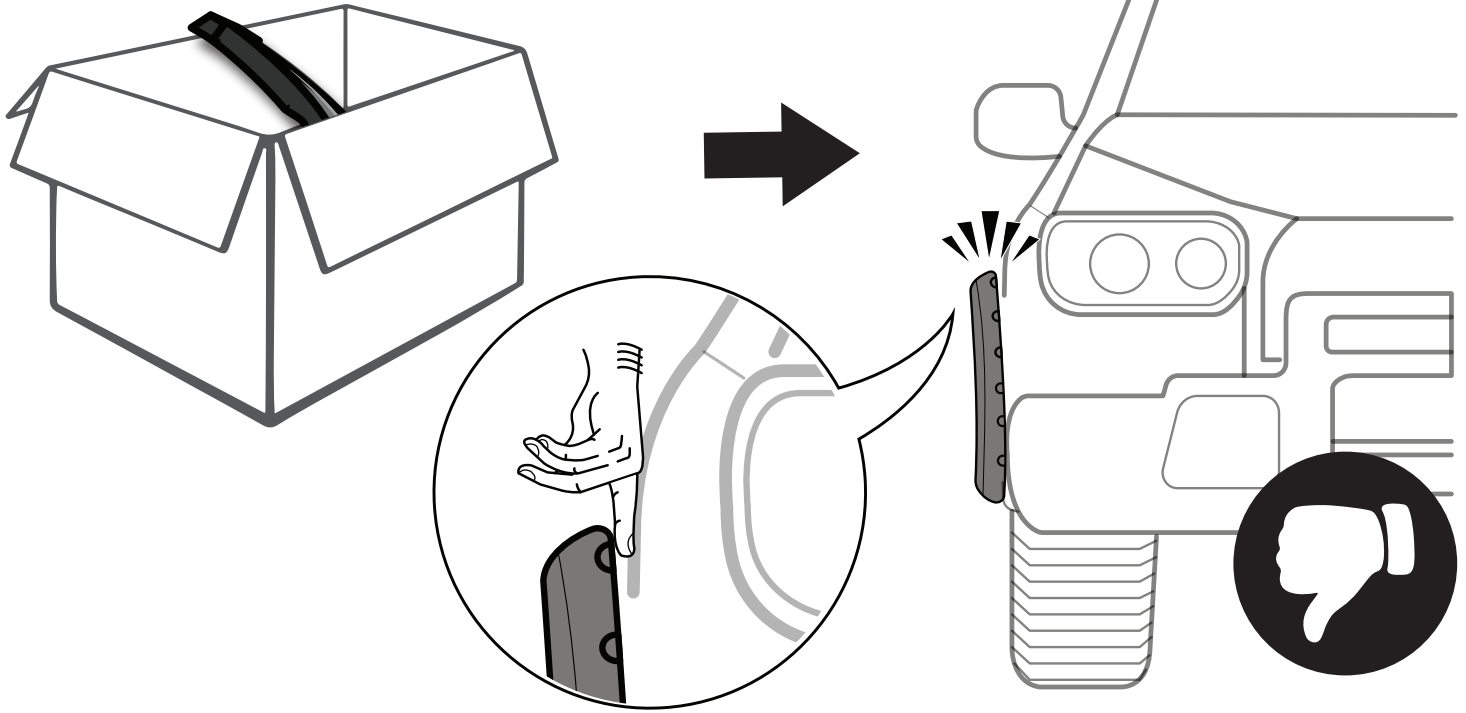

# SOLUTION!

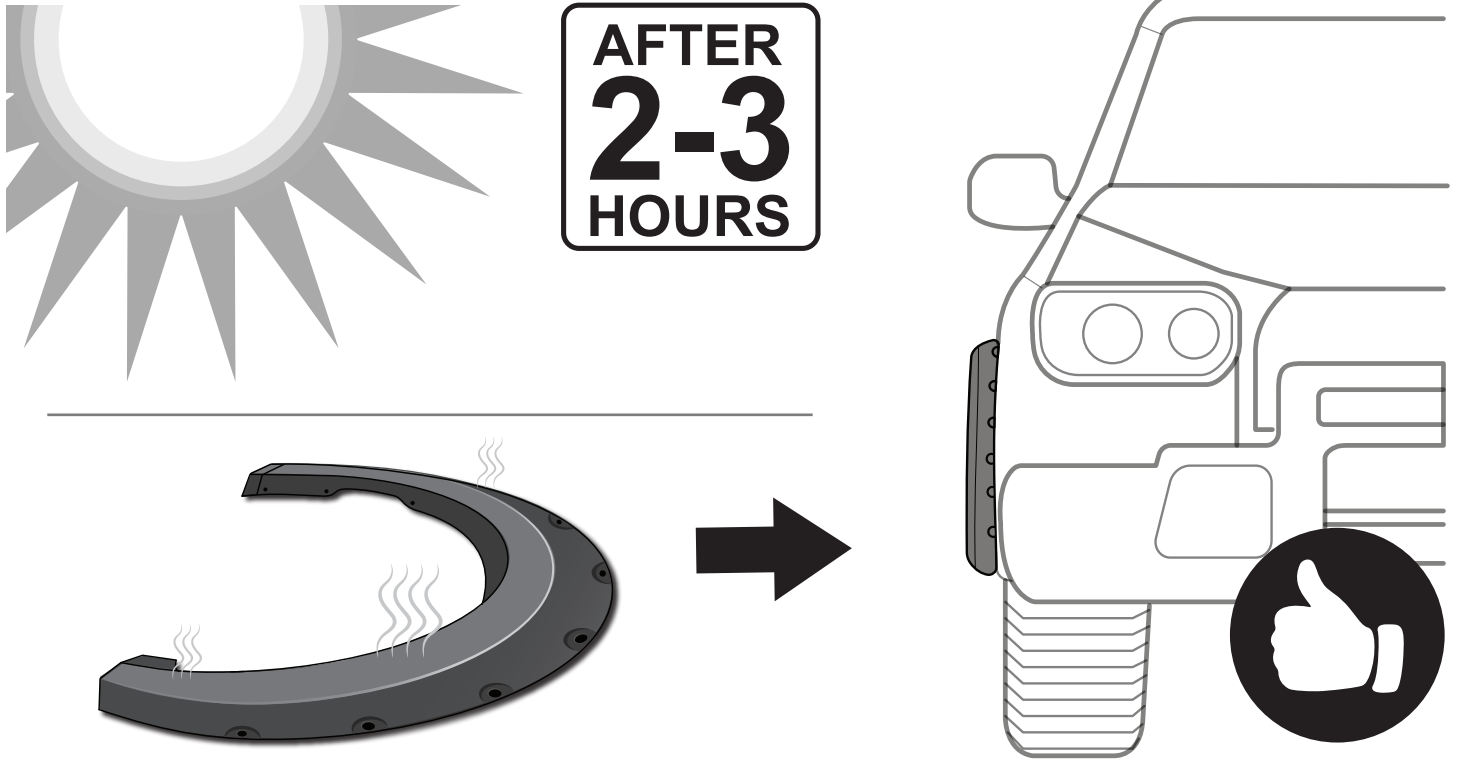

\*In winter, heat gun or hair dryer may be used instead.