



## TYGER RIDER®

TG-SS2N35108

### BEFORE INSTALLATION

READ INSTRUCTIONS CAREFULLY BEFORE STARTING INSTALLATION. REMOVE CONTENTS FROM BOX AND VERIFY ALL PARTS ARE PRESENT. FAILURE TO IDENTIFY DAMAGE BEFORE INSTALLATION COULD LEAD TO A REJECTION OF ANY CLAIM. IF MISSING PARTS OR ANY DAMAGE FOUND, PLEASE TAKE A PICTURE FOR THE CLAIM PURPOSE. TO FILE YOUR CLAIM, PLEASE VISIT: [WWW.TYGERAUTO.COM/CONTACT](http://WWW.TYGERAUTO.COM/CONTACT)

### TORQUE VALUES

Fastener Size	Class 8.8 Torque (ft-lbs)	Class 10.9 Torque (ft-lbs)
6mm	6-7	6-7
8mm	15-16	22-23
10mm	31-32	44-45
12mm	54-55	78-79
14mm	87-88	125-126

## Parts List

- x1 Driver/Left Sidebar
- x1 Passenger/Right Sidebar
- x3 Driver/Left Mounting Brackets
- x3 Passenger/Right Mounting Brackets
- x12 8-1.25mm x 30mm Hex Bolts
- x6 8mm x 24mm OD x 2mm Flat Washers
- x6 8mm x 16mm OD x 1.6mm Flat Washers
- x12 8mm Lock Washers
- x6 8mm Nylon Lock Nuts
- x12 8-1.25mm x 25mm Combo Bolts

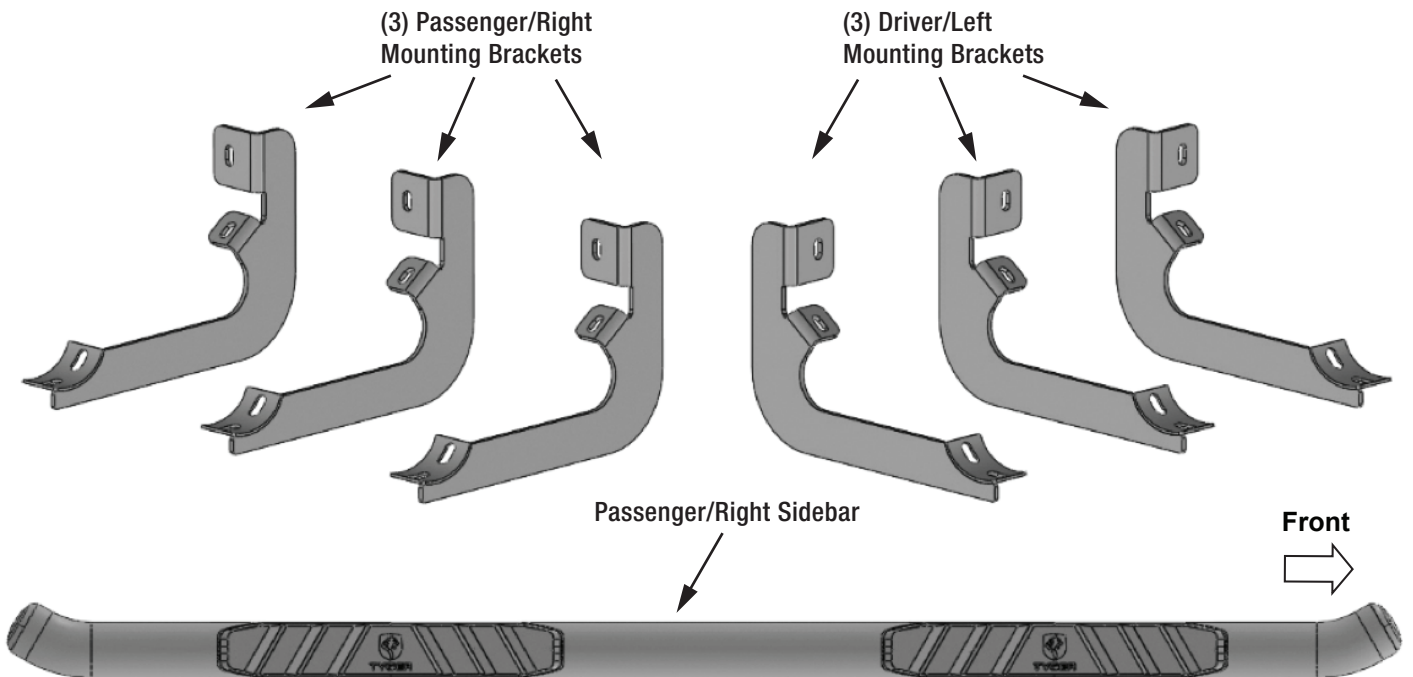



## PROCEDURE:

REMOVE CONTENTS FROM BOX. VERIFY ALL PARTS ARE PRESENT. READ INSTRUCTIONS CAREFULLY BEFORE STARTING INSTALLATION.

### STEP 1

Start installation on the Passenger/Right side of the vehicle and locate the front factory threaded holes or stud located on the side of the inner body panel, (Figs 1 & 2). There are (4) mounting locations along the body panel. Bracket installation will use the **1st, 2nd** and **4th** mounting locations.

**NOTE:** Remove the plastic plug or any insulation on the side panel to locate the threaded holes.

#### Passenger/Right Side Installation Pictured

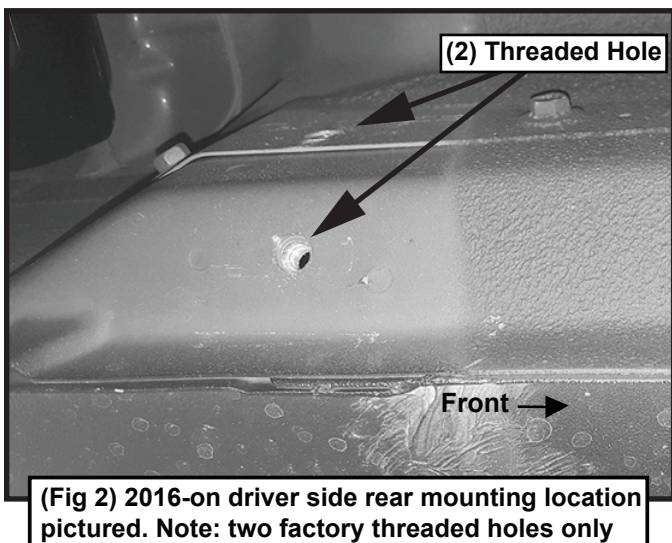
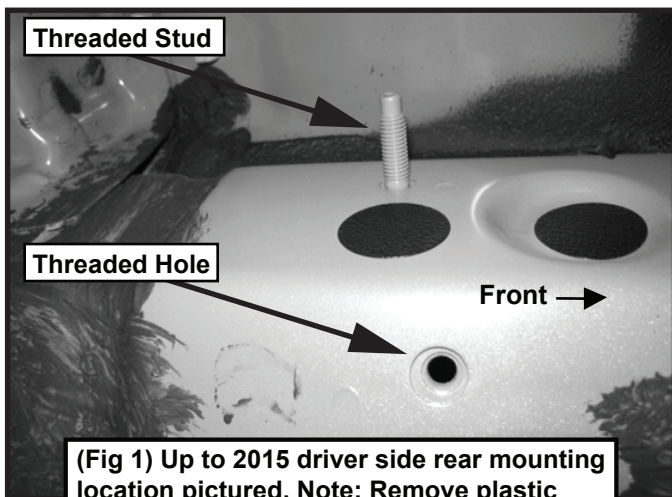

### STEP 2

Determine if the vehicle has (2) threaded holes or (1) stud and (1) threaded hole

**Models with threaded stud:** Select (1) Passenger/Right Mounting Bracket. Attach Bracket to stud with (1) 8mm x 24mm Flat Washer and (1) 8mm Nylon Lock Nut. Attach the Bracket to the threaded hole with (1) 8mm x 30mm Hex Bolt, (1) 8mm Lock Washer and (1) 8mm x 16mm Flat Washer to attach the Bracket to the threaded insert hole on the body panel, (Figs 1 & 3). DO NOT tighten hardware.

**Models without threaded stud:** Select (1) Passenger/Right Mounting Bracket. Attach the Bracket to the upper threaded hole with (1) 8mm Hex Bolt, (1) 8mm Lock Washers and (1) 8mm x 24mm Flat Washers. Attach the Bracket to the lower threaded hole with (1) 8mm Hex Bolt, (1) 8mm Lock Washer and (1) 8mm x 16mm Flat Washer, (Figs 2, 3 & 4). DO NOT tighten hardware.

#### Passenger/Right Side Installation Pictured

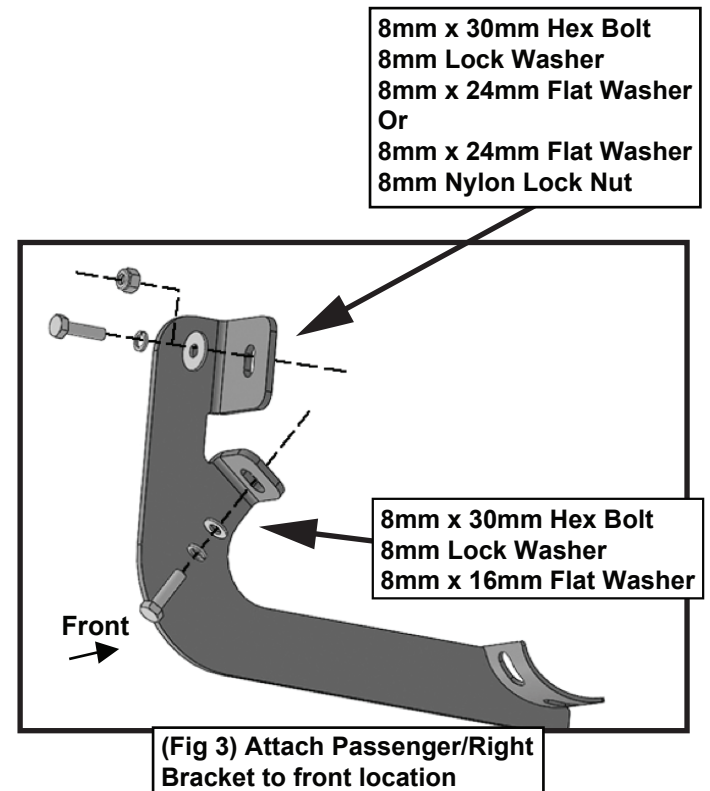

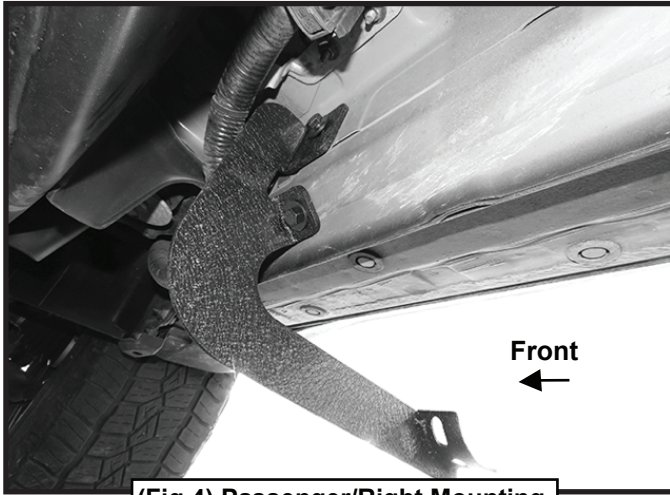

(Fig 4) Passenger/Right Mounting Bracket attached to front location

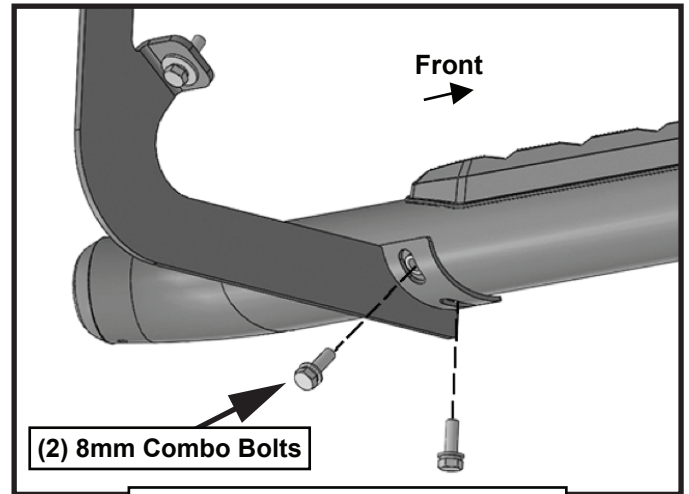

(Fig 5) Attach the Passenger/Right Sidebar to the Mounting Brackets

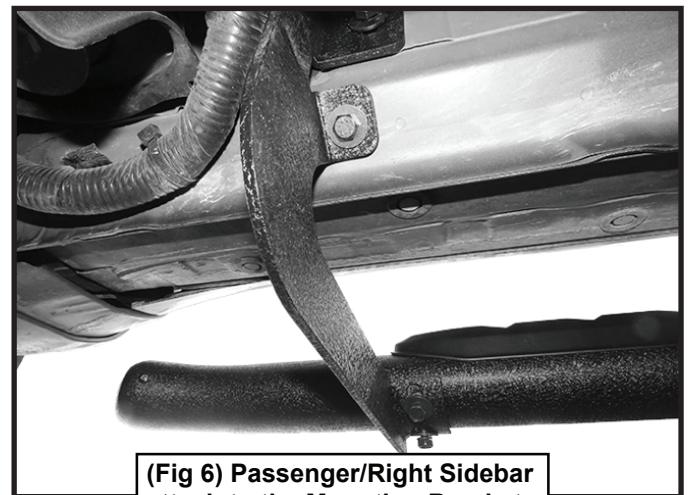

(Fig 6) Passenger/Right Sidebar attach to the Mounting Brackets

## STEP 3

Repeat **STEPS 1 & 2** to attach the remaining (2) Passenger/Right Mounting Brackets.

**NOTE:** The cradles on the Mounting Brackets should be facing the rear of the vehicle.

## STEP 4

Carefully unwrap and select the Passenger/Right Sidebar. Use the illustration above to help determine the correct Sidebar. With assistance, attach the Sidebar to the top of the Mounting Brackets with (6) 8mm Combo Bolts, (Figs 5 & 6). **DO NOT** tighten hardware.

**IMPORTANT:** **DO NOT** slide, (front to back), the Sidebar on the Brackets or damage to the finish may result.

Passenger/Right Side Installation Pictured

## STEP 5

Level and adjust the Sidebar and tighten all hardware.

## STEP 6

Repeat **STEPS 1—5** to attach the Driver/Left Sidebar.

## STEP 7

Do periodic inspections of the installation to make sure that all hardware is secure and tight.